

100
S E R I E S

pure water
dispenser®

User's Manual



IMPORTANT: This manual includes important safety material; please read all instructions before plugging power supply cord into receptacle.

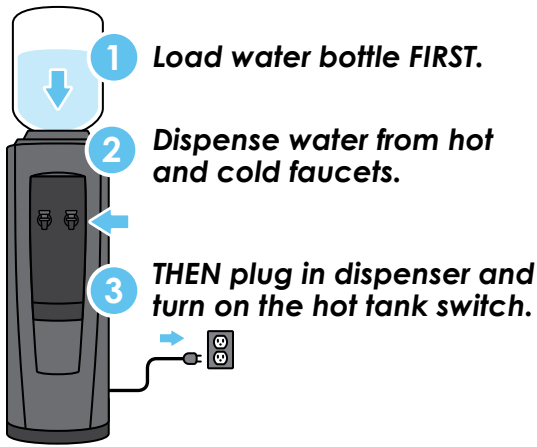

STOP & READ DIRECTIONS before plugging in dispenser.

Read complete **HOW TO INSTALL** instruction sequence before plugging in and turning on dispenser. Failure to follow proper installation instructions may cause damage to water dispenser.

SAFETY PRECAUTIONS

Basic safety precautions should be followed when using electrical appliances, including:

- Only plug in dispenser in the sequence the manual indicates (see HOW TO INSTALL AND USE).
- In accordance with these instructions, the dispenser must be properly located and installed before use (see HOW TO INSTALL AND USE).
- Use only bottled water in the dispenser.
- Keep all gasoline or other flammable vapors and liquids away from this and other appliances.
- Dispenser must be unplugged before cleaning, sanitizing or repairing (see CLEANING AND SANITIZING).
- Wipe up any water spills immediately after loading or unloading water bottles.
- Do not use with water that is microbiologically unsafe or of unknown quality.
- The dispenser heats water to a temperature as high as 198° F (92.2° C). Water temperatures above 125° F (52° C) can cause severe burns or death from scalding. Most at risk of being scalded are children, the disabled and the elderly.
- Ensure the dispenser stands upright for 2 hours before loading water bottle, plugging in and turning unit on.
- Always lift dispenser by handle located on rear of unit. Lifting dispenser by faucets or faucet handles will damage the unit.
- Follow proper grounding safety precautions and instructions prior to plugging in the unit (see GROUNDING SAFETY PRECAUTIONS AND INSTRUCTIONS).
- Supervise children when using the dispenser (see CHILD SAFETY).

GROUNDING SAFETY PRECAUTIONS AND INSTRUCTIONS

⚠ WARNING: The dispenser must be grounded – if the appliance is improperly grounded, the result could be electric shock.

Ensure that the available power supply matches the dispenser's voltage specifications indicated on the nameplate label (located at the rear). Please ensure that dispenser is set up so access to the power outlet and plug is unobstructed.

💡 IMPORTANT: To provide additional protection from the risk of shock, the dispenser MUST be connected to a ground fault circuit interrupter (GFCI) outlet at all times. Use of an extension cord will void any warranties. See warranty document for complete terms and conditions.

CHILD SAFETY

⚠ CAUTION: Supervise children when using the dispenser.

The hot dispenser faucet is equipped with a child safeguard that reduces the risk of hot water being dispensed accidentally or by small children. To dispense hot water, squeeze the front and back of the left faucet handle together and push down. Do not allow children to hang, climb or stand on the dispenser; the dispenser could fall over and the child could be injured.

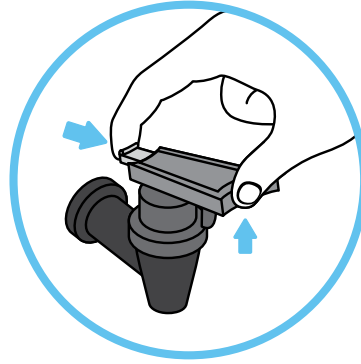

RECEIVING

Inspect the dispenser box carefully for any evidence of shipping or handling damage before signing to receive goods. In case of shipping damage, claims should be filed immediately with the carrier.

HOW TO INSTALL AND USE

⚠ WARNING: Read through every step in HOW TO INSTALL AND USE before plugging in or turning unit on.

1. Keep dispenser unplugged and in the off position until the water bottle has been loaded and water flows through the faucets.
2. Ensure dispenser stands upright for a minimum of 2 hours before loading water bottle, plugging in and turning on dispenser.
3. Place dispenser a minimum of 2 inches away from the wall to ensure ventilation.
4. Install dispenser on a level floor strong enough to support it when fully loaded.
5. Do not install dispenser where it will be subject to direct sunlight, heat or moisture.
6. Do not install dispenser where the temperature will go below 50° F (10° C) or above 100° F (38° C).
7. Wipe down the water bottle cap and neck to ensure there is no debris.
8. Remove tamper-evident seal from plastic bottle cap. Do NOT remove plastic cap if using a no-spill water bottle.

💡 NOTE: Be sure to use a no-spill water bottle. Using bottles without the no-spill feature can cause leaking to occur.



9. Load water bottle by lifting and inserting it onto the probe, ensuring bottle is fully aligned with the dispenser and centered over the probe. Be certain fingers and other body parts are clear of underside of bottle. Apply slight pressure until the shoulder of the bottle rests on the top of the no-spill dispenser insert. Water will begin to flow into the tank causing air bubbles in the bottle.

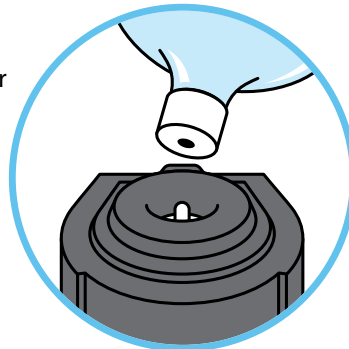

⚠ CAUTION: When loading bottle, lift with legs to prevent injury.

10. Place a cup under the hot dispenser faucet. Squeeze the front and back of the left faucet handle together and push down until water flows continuously. Depress the cold water faucet to make sure there is a continuous flow of water.
11. Now, plug dispenser into the power supply using a GFCI outlet. Turn on the hot tank heater switch located at the rear of the dispenser. When the switch is turned on, a red light will illuminate. When the hot tank reaches operating temperature, the red light will go off.
12. Install drip tray.
13. Dispense water.

 **NOTE:** It takes approximately 1 hour for water in the dispenser to become hot.

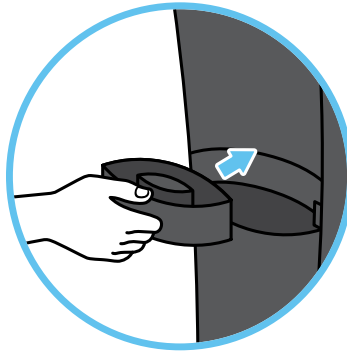

CLEANING AND SANITIZING

Your water dispenser should be thoroughly cleaned at least twice a year. If your dispenser hasn't been used in a while, we recommend [flushing](#) the equipment prior to cleaning. Here are instructions for do-it-yourself cleaning:

Before you start cleaning, wash your hands thoroughly with soap and water for at least 20 seconds.

 **TIP:** The best time to clean your dispenser is when the existing water bottle is empty.

WHAT YOU'LL NEED:

- 70% rubbing alcohol or disinfecting wipes
- Dishwashing soap
- Clean cloth or soft brush
- Disposable non-latex gloves
- Hot water (about a gallon)
- Heat-resistant container, like a metal pot
- Towels to absorb any water spills

 **WARNING:** Always use caution when handling hot water.

1. Turn off the hot tank heater switch on the back of the dispenser and unplug your unit (*Fig 1*). Let the unit stand for one hour before cleaning to allow the hot tank to cool. (**NOTE:** If your cooler does not dispense hot water, you can proceed immediately to Step 2.)
2. Remove the water bottle and drain the water reservoir by dispensing water through the hot and cold spigots.
3. Clean the cabinet, bottle receptacle and spigots with 70% rubbing alcohol or disinfecting wipes. Vacuum or wipe the grill on the back of the dispenser to remove any dust.
4. Clean the drip tray and grill by emptying the tray and cleaning the tray and grill with dishwashing soap or by placing them on the top rack of the dishwasher (*Fig 2*).

 **TIP:** The drip tray and grill should be cleaned monthly.

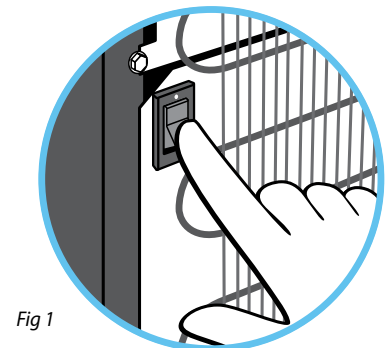

Fig 1

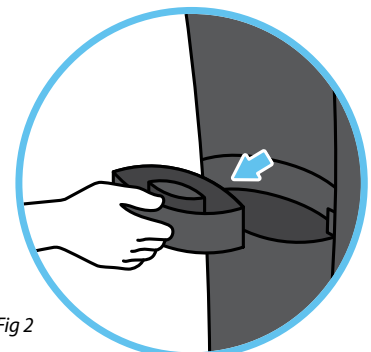

Fig 2

5. Remove the no-spill dispenser insert.
 - If your insert has a notch, remove by pulling up on the notch located on the top rear of the dispenser (*Fig 3a*).
 - If your dispenser insert has arrows, twist the insert to align the “Open” arrows. Pull up (*Fig 3b*).

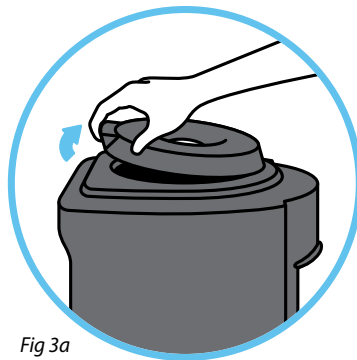

Fig 3a

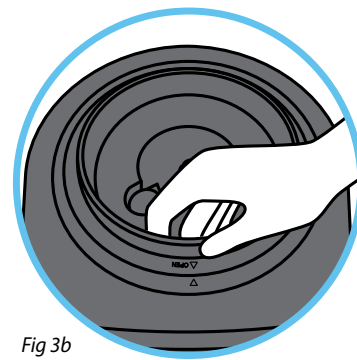

Fig 3b

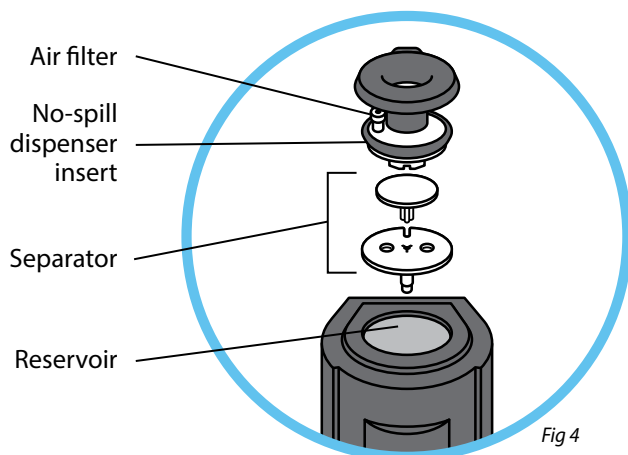

Fig 4

6. Remove the separator by pulling it straight out. Make note of the separator positioning before removing so that it can be re-installed correctly. Clean these parts with dishwashing soap and let them dry thoroughly (*Fig 4*).

7. Carefully pour hot water into the reservoir until it is $\frac{3}{4}$ full. Let the water sit for 5 minutes (*Fig 5*). Always use caution when handling hot water.

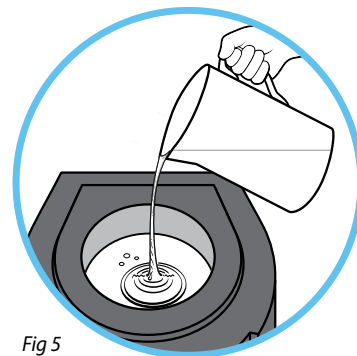

Fig 5

8. Wearing disposable non-latex gloves, wipe the inside of the reservoir with a clean cloth or soft brush. Use caution as the water may still be hot to the touch (*Fig 6*).
9. Completely drain the water from the reservoir by dispensing the water through the hot and cold spigots into a container.
10. Repeat steps 7 and 9 to completely flush the dispenser. It is not necessary to wipe the inside of the reservoir a second time.
11. Replace the separator and the no-spill dispenser insert. Wipe down the cooler and the surrounding area to dry any water spills.

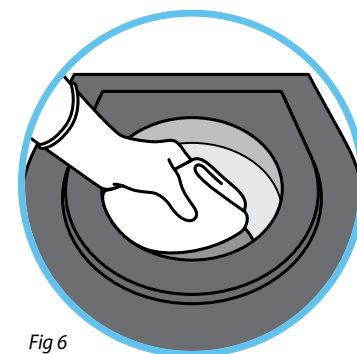
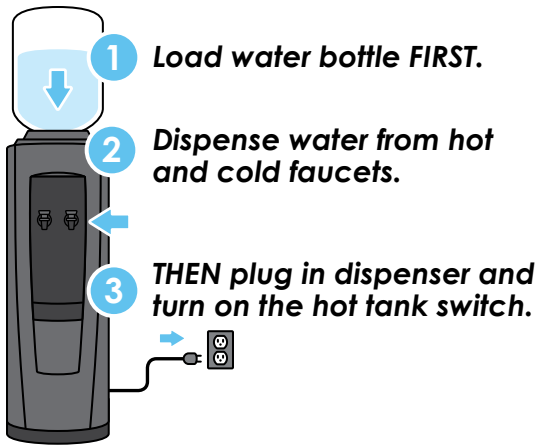

Fig 6

12. Wash your hands thoroughly with soap and water for at least 20 seconds. Install a full water bottle on the dispenser. Dispense water through the hot and cold spigots. **Plug it in and turn on the hot tank heater switch located at the rear of the dispenser.**



⚠ WARNING: Dispense water through the hot and cold spigots before plugging in and turning on the hot tank switch. Failure to follow proper installation instructions may cause damage to water dispenser.

TROUBLESHOOTING

⚠ WARNING: Always turn off dispenser and unplug from power outlet before inspecting or starting any maintenance.

WATER IS LEAKING

- The no-spill bottle was loaded with the cap removed.
- Bottle may have a puncture or crack. Remove and install new bottle.

WATER DOES NOT FLOW FROM DISPENSER

- Make sure bottle is not empty; if empty, replace bottle.
- Make sure to push down on faucet fully.
- Inspect to see if there is a pinhole in the bottle; if so, replace bottle.
- Check valve on no-spill dispenser insert; make sure it is allowing air into the reservoir.
- Remove bottle from dispenser. Dispense two cups of water. Place the bottle back on the dispenser.

WATER TASTES BAD

- Dispenser may need to be cleaned (see CLEANING AND SANITIZING).

WATER NOT HOT OR COLD ENOUGH

- Check to make sure dispenser is plugged in and the switch is turned on.
- Test electrical outlet by plugging in another electrical device to ensure outlet is working properly.
- A fuse may be blown or the circuit breaker may be tripped; if needed, replace fuse or reset breaker.
- Dispenser may be placed in direct sunlight or may be too close to a heat source; try moving dispenser into a cool shaded area.

DISPENSER IS NOISY

- Make sure the dispenser is on a level floor strong enough to support it when fully loaded.
- It is normal for the bottle to make a gurgling noise as water fills the tank.
- It is normal for the dispenser or water bottle to shake when the cooling system cycles off.
- Some operating noise from the compressor and hot tank is normal.

PARTICLES FLOATING IN WATER

- Dispenser may need to be cleaned (see CLEANING AND SANITIZING).
- Always ensure label is fully removed from bottle cap before placing on dispenser.
- Call your water service provider if problem persists.

DISPENSER NEEDS TO BE STORED

- Always drain water completely using the hot tank drain located on the back of the dispenser before shipping or storing.

TO PROPERLY DISPOSE OF YOUR DISPENSER

- Your old dispenser may have used a regulated refrigerant in its cooling system. These refrigerants are believed to harm stratospheric ozone. If you are throwing away your old dispenser, make sure the refrigerant is removed and recovered for proper disposal by an EPA-certified technician. If you intentionally release this refrigerant, you can be subject to fines and imprisonment under provisions of environmental legislation.

 **IMPORTANT:** The customer acknowledges that water, like other liquids, can cause damage to surfaces. The customer takes full responsibility for placing the dispenser within a residence or business and acknowledges that failure to address drips, leaks or spillages is at the customer's risk.

 **WARNING:** *The Limited 1-Year Warranty and Underwriters' Laboratory and CE listings for the dispensers are invalidated if any alterations, modifications, or use or misuse in combination with any other machines or devices is deemed to be the source of any claim. See warranty document for complete terms and conditions. DS Services of America, Inc. accepts no liability (including for bodily injury) resulting from any alterations, misuse, neglect, accidents, improper installations or repairs. The appliance is not intended for use by persons (including children) with reduced physical, sensory or mental capabilities, or lack of experience and knowledge without supervision by a person responsible for their safety.*